

5000 HEADBOARD COMPONENTS

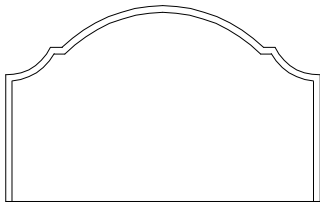

A x 1 pc



B x 2 pcs



C x 4 pcs (8x20mm)



F x 6 pcs (4x20mm)



I x 8 pcs (M6)



L x 1 pc (4mm)



D x 4 pcs (M8)



G x 1 pc (5mm)



J x 4 pcs (M6)



E x 4 pcs (M8)



H x 4 pcs (6x30mm)



K x 4 pcs (M6)

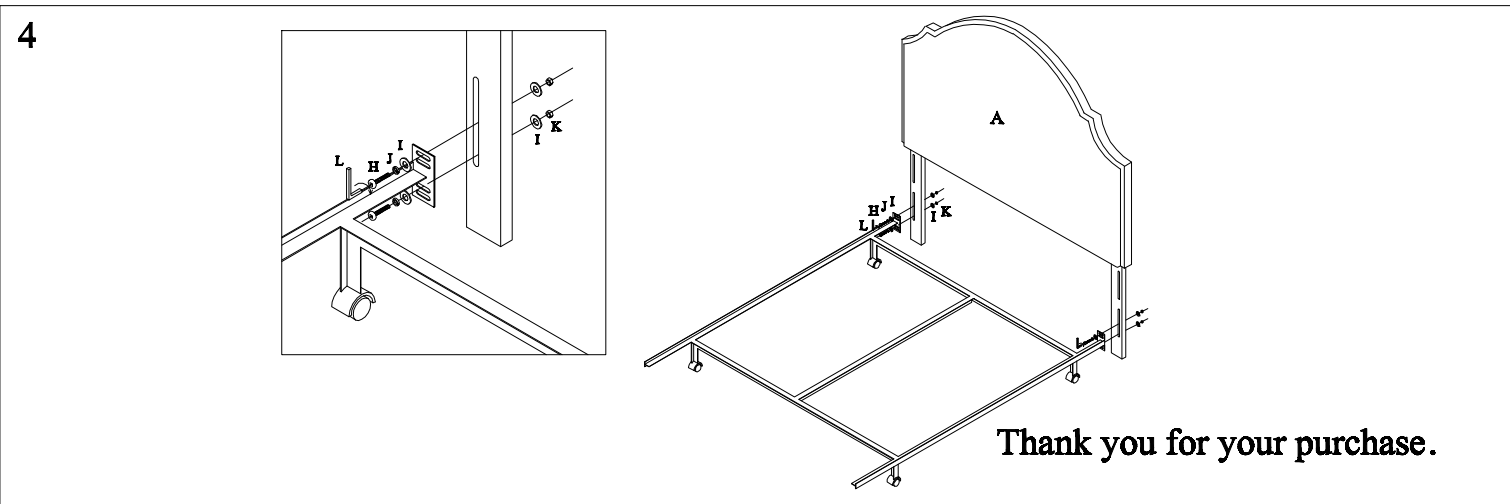
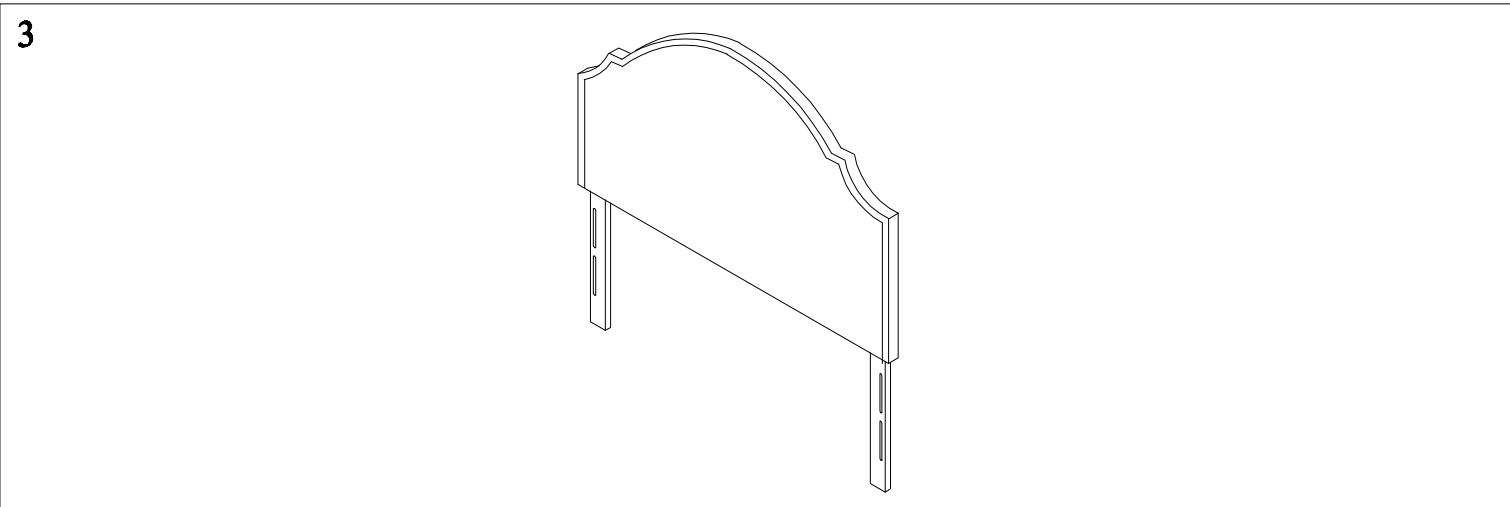
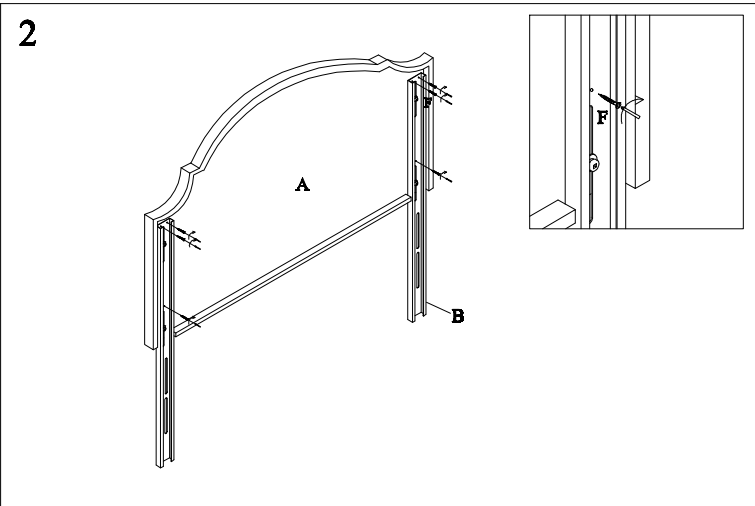
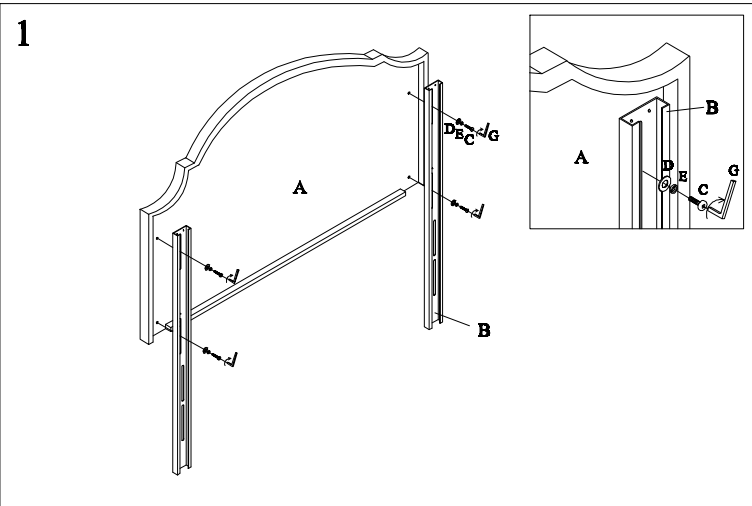

Thank you for your purchase.