

## HEADBOARD SET ASSEMBLY INSTRUCTION (TOTAL 1 BOX)

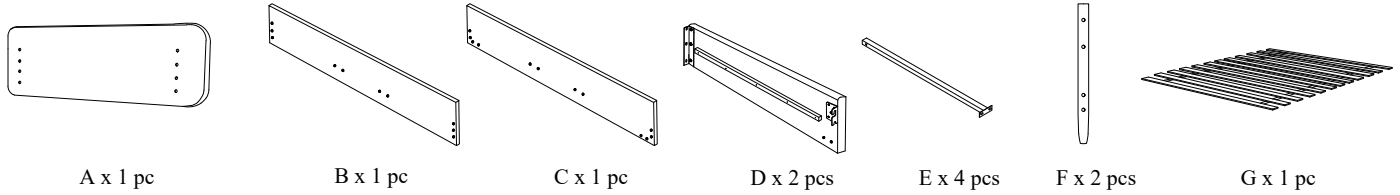

Please read over the instructions, it will be a time-saver in the long run.

Note: Before assembly, please be sure to work on a soft flat surface to avoid any damage to the finish.

Please leave bolts loosened until all bolts are placed before tightening completely.

Part#	Picture	Description	QTY	Location	Part#	Picture	Description	QTY	Location
H		Center leg	2	Embossed film wrap	S		Spring washer Ø8	16	Hardware pack
I		Triangle connection piece	2	Embossed film wrap	T		Spring washer Ø6	6	Already in place
J		Front legs	2	Embossed film wrap	TA		Spring washer Ø10	2	Hardware pack
K		Wooden pegs	8	Plastic bag	U		Flat washer Ø6x25mm	6	Already in place
L		Bolt Ø6x30mm	6	Already in place	UA		Flat washer Ø10x25mm	2	Hardware pack
M		Bolt Ø8x30mm	20	Already in place	V		Flat washer Ø8x18mm	8	Hardware pack
N		Bolt Ø8x60mm	8	Hardware pack	W		Flat washer Ø8x22mm	20	Already in place
O		Bolt Ø8x70mm	4	Hardware pack	X		Flat washer Ø8x25mm	8	Hardware pack
P		"L" Wrenches Ø4	1	Hardware pack	Y		Spanner Ø14	1	Hardware pack
Q		"L" Wrenches Ø5	1	Hardware pack	YA		Spanner Ø17	1	Hardware pack
R		Nut Ø8	4	Hardware pack	Z		Screws 4x30mm	24	Hardware pack
RA		Nut Ø10	2	Hardware pack					

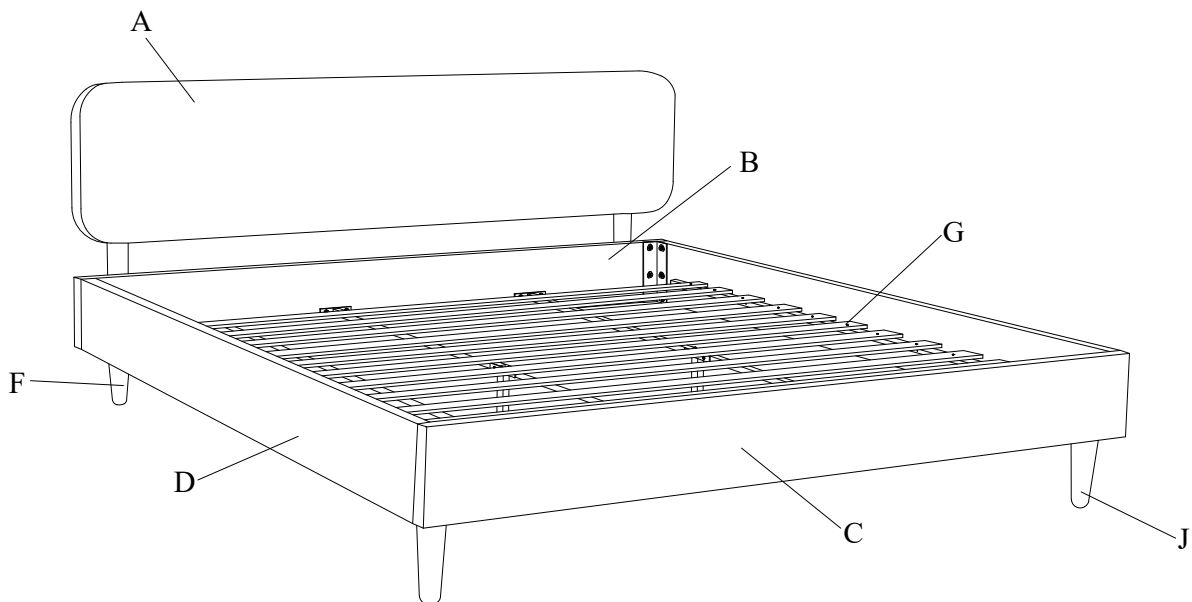

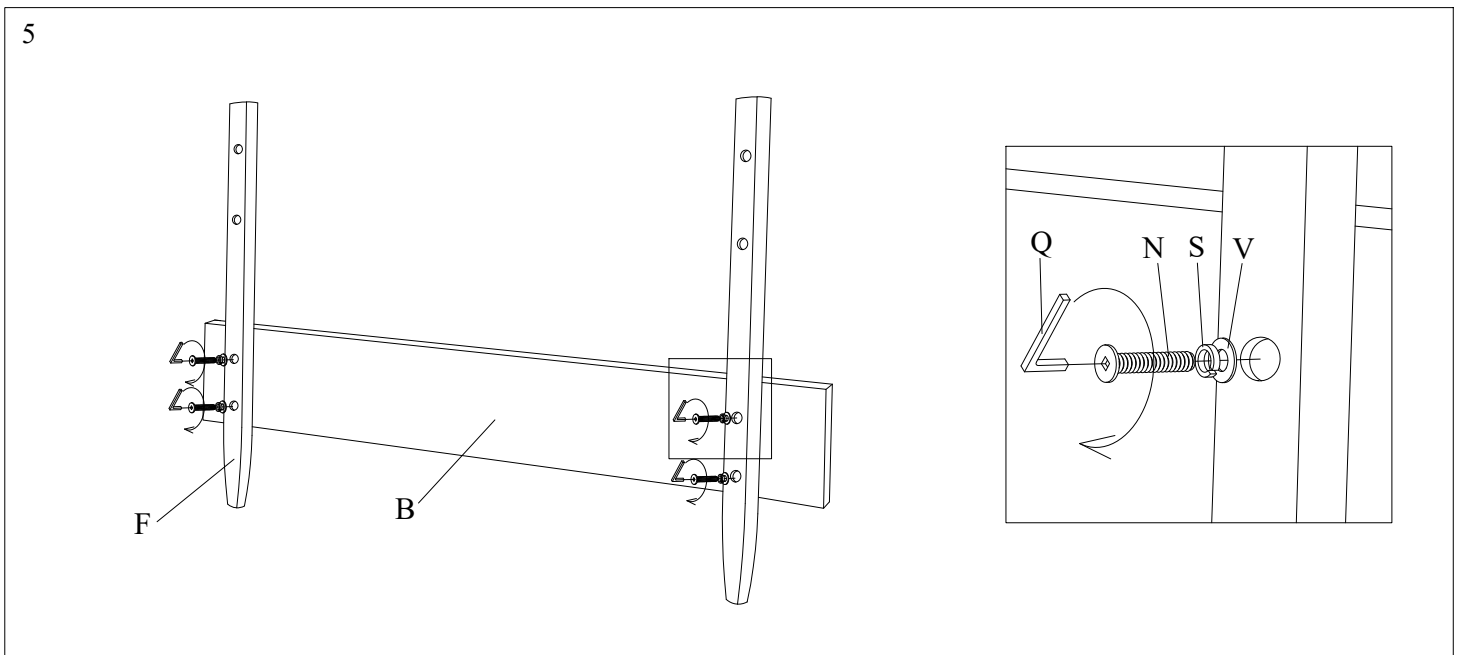
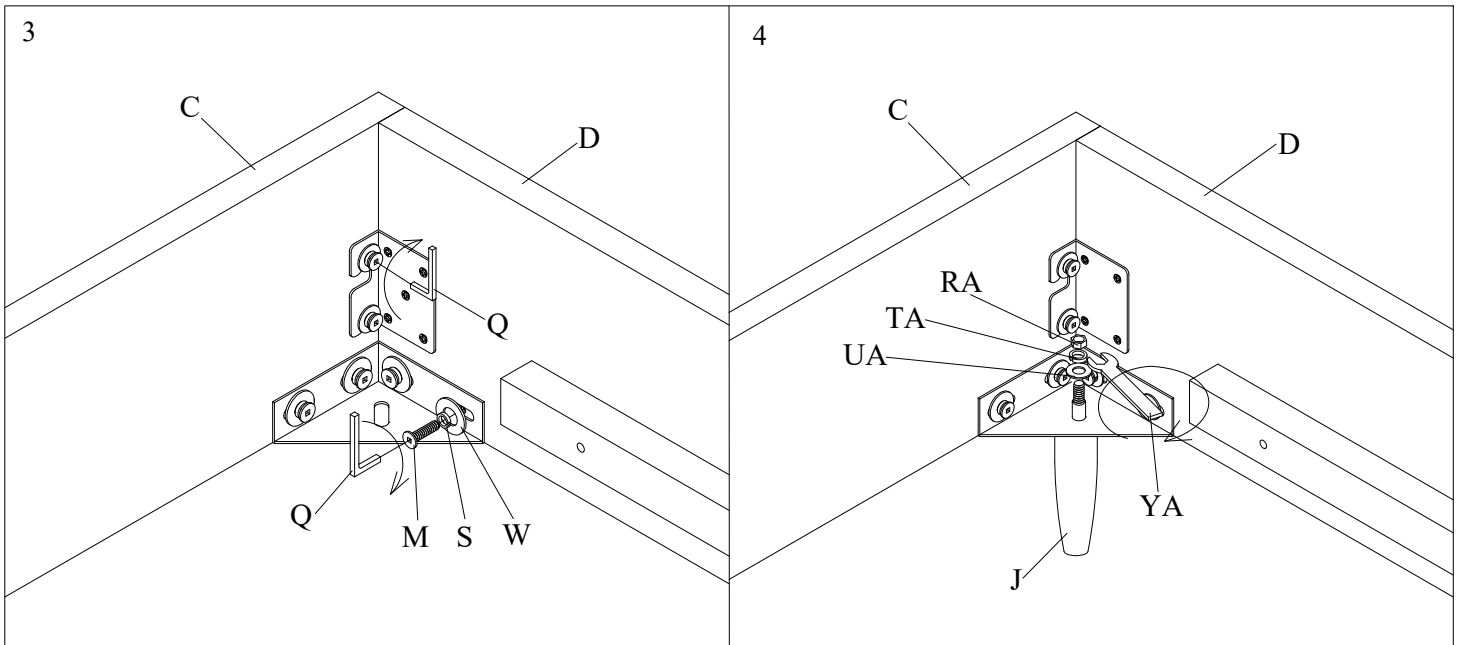
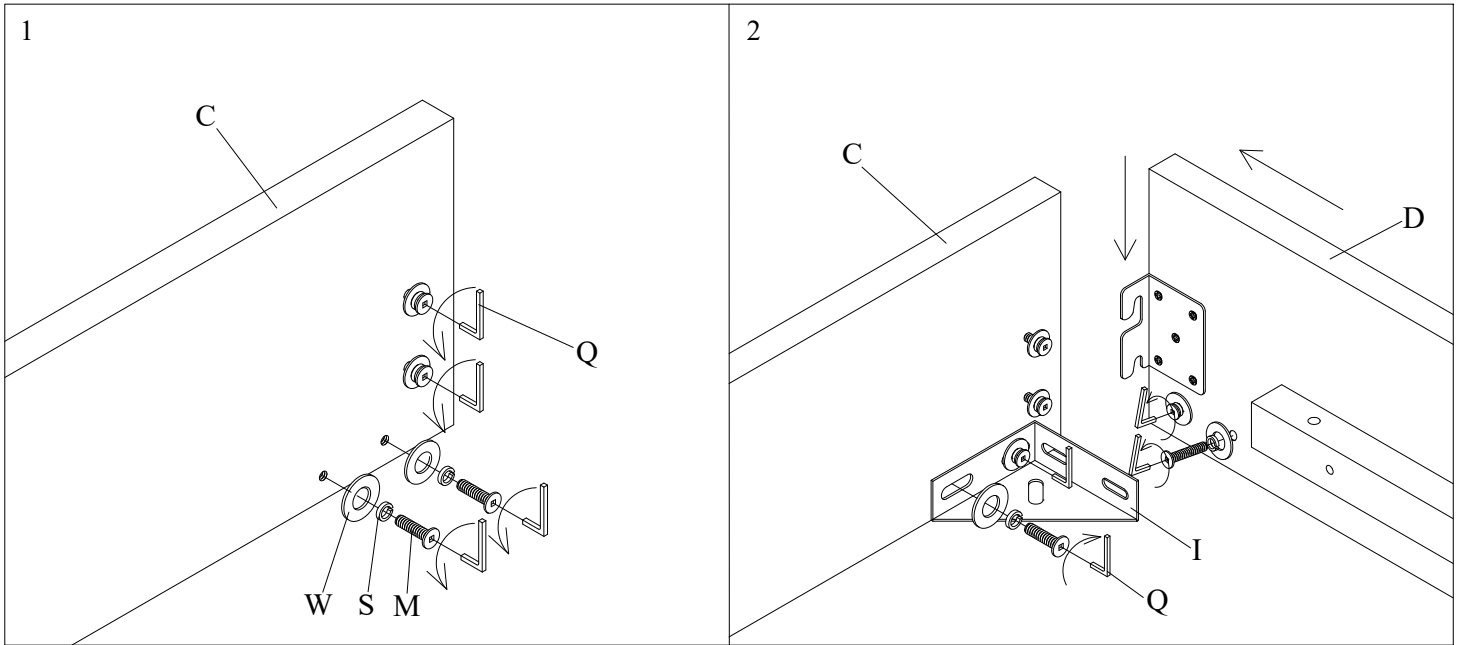

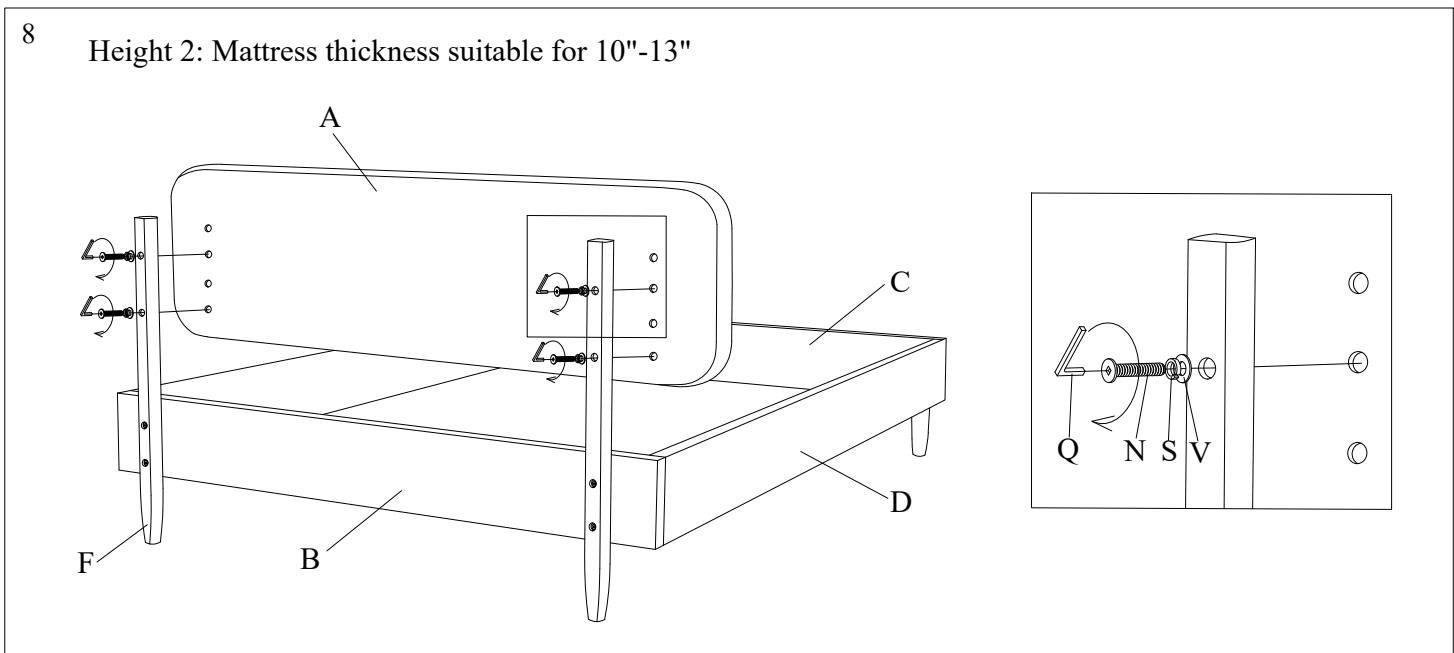
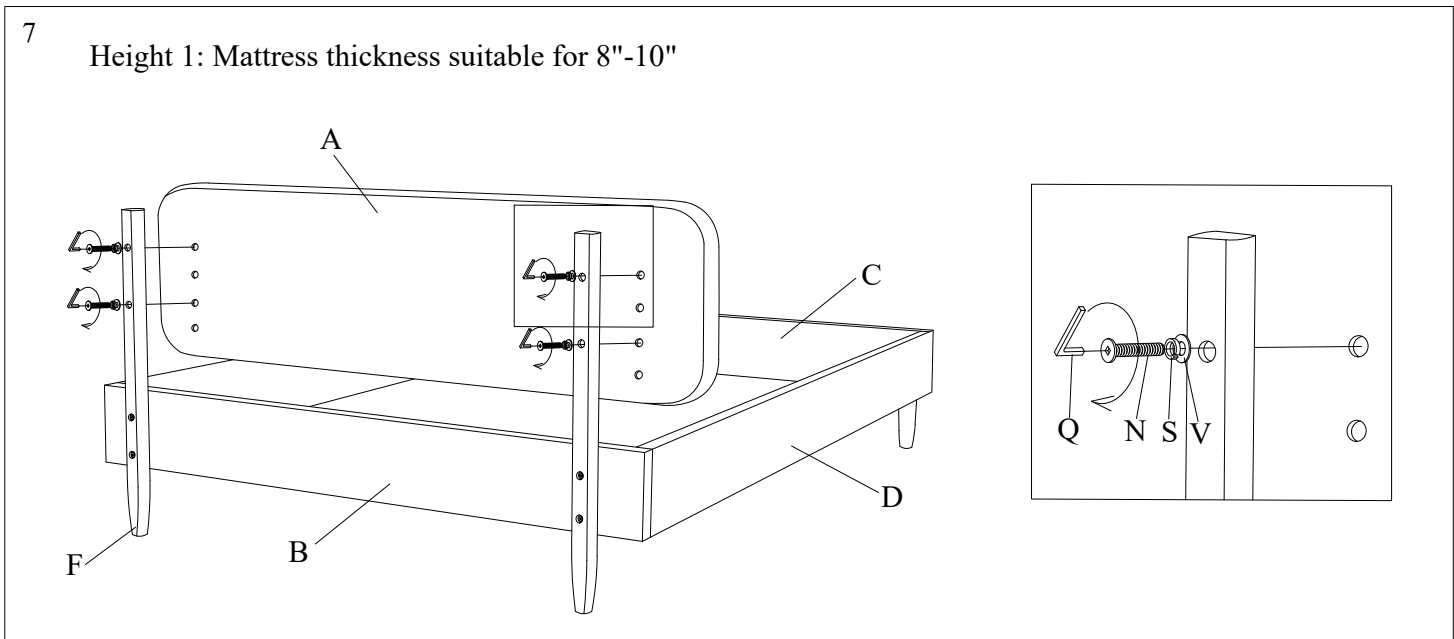
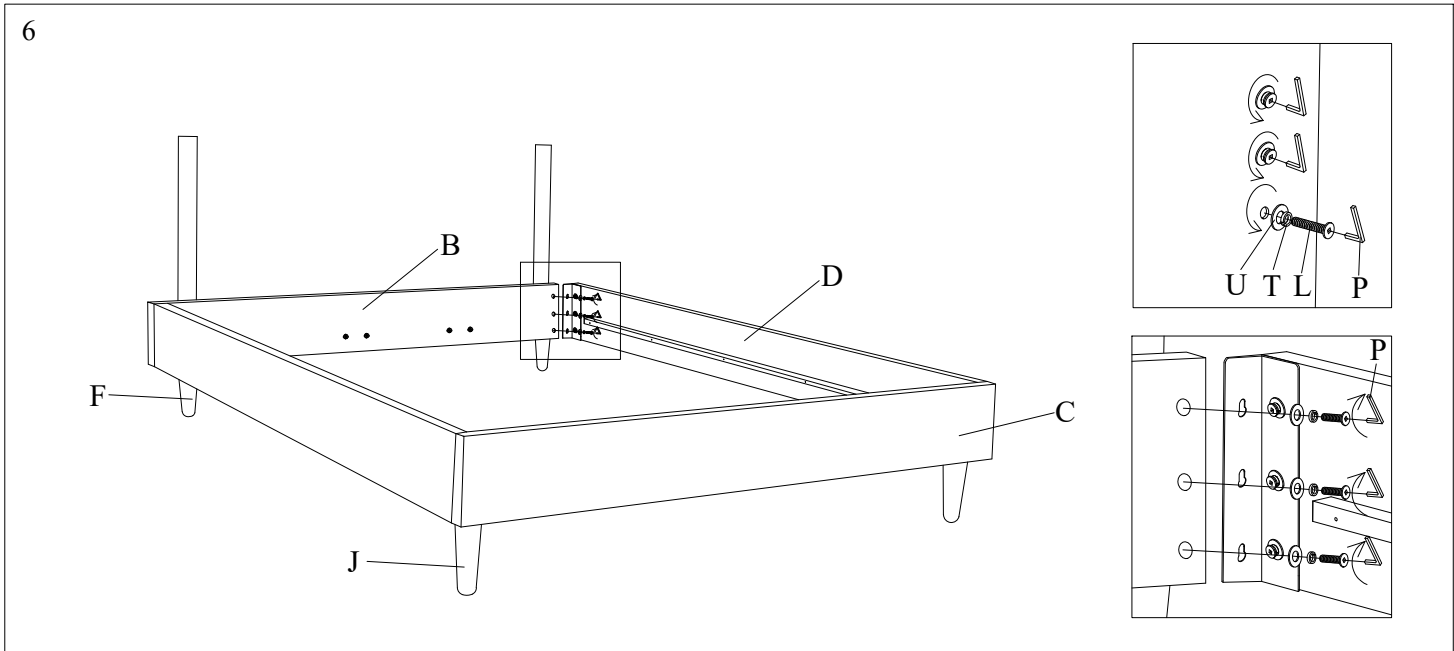

9

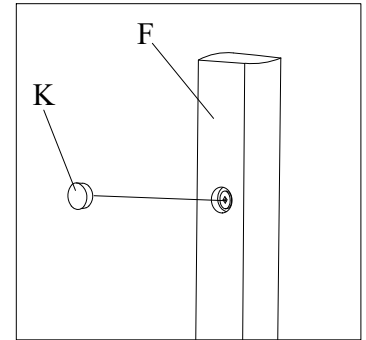
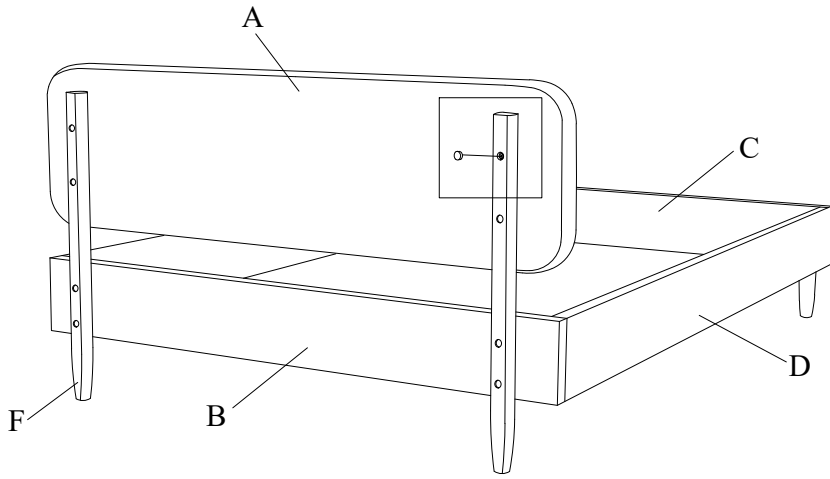

10

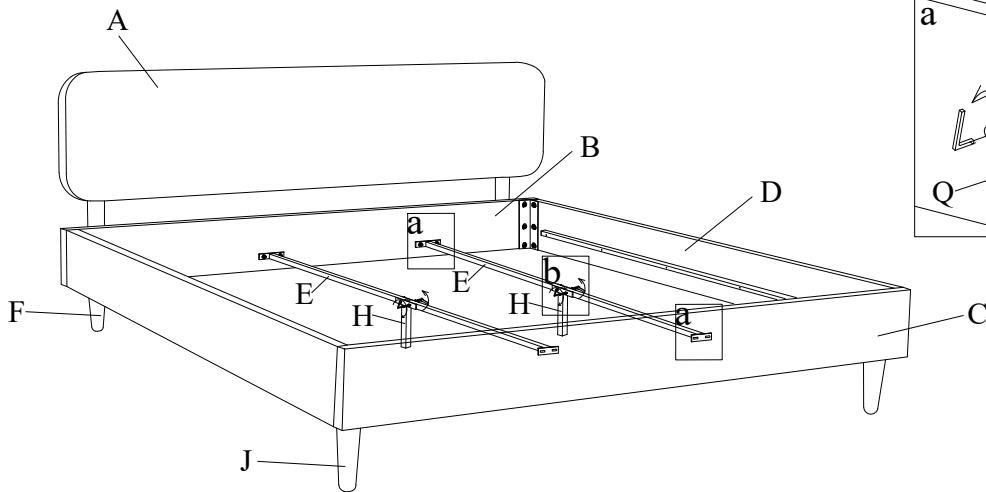

step1 → step2

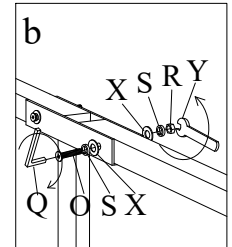
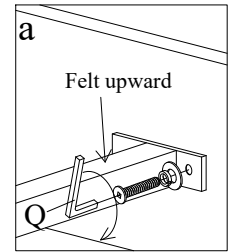
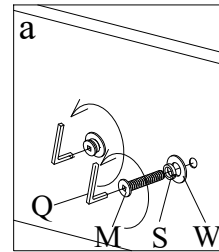

11

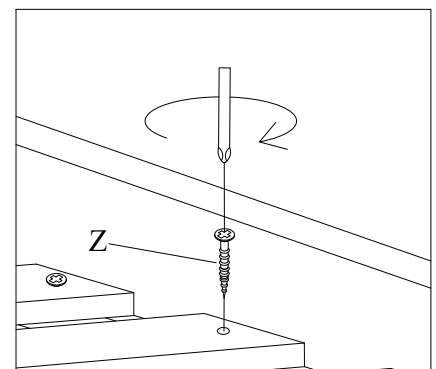
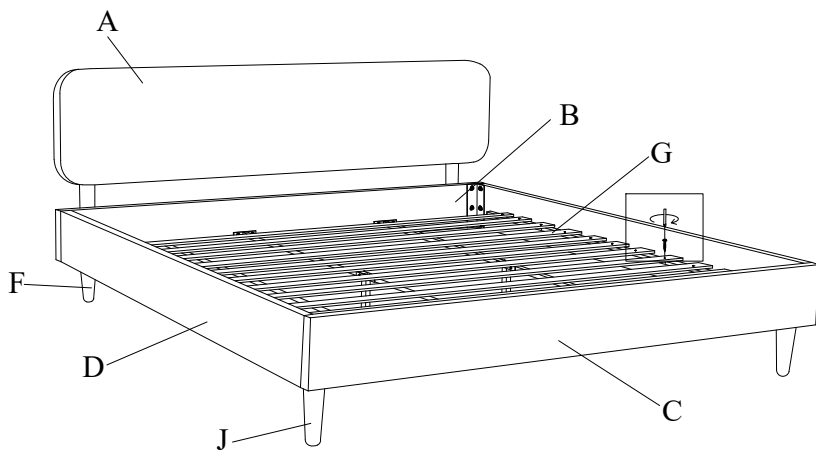

Screwdriver required, not included