

# HEADBOARD ASSEMBLY INSTRUCTION (TOTAL 1 BOX)

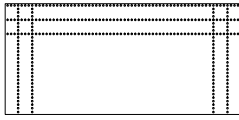

A x 1 pc



B x 2 pcs

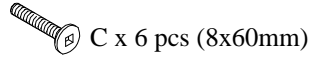

C x 6 pcs (8x60mm)

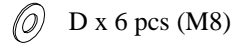

D x 6 pcs (M8)

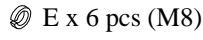

E x 6 pcs (M8)

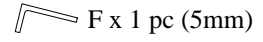

F x 1 pc (5mm)

1

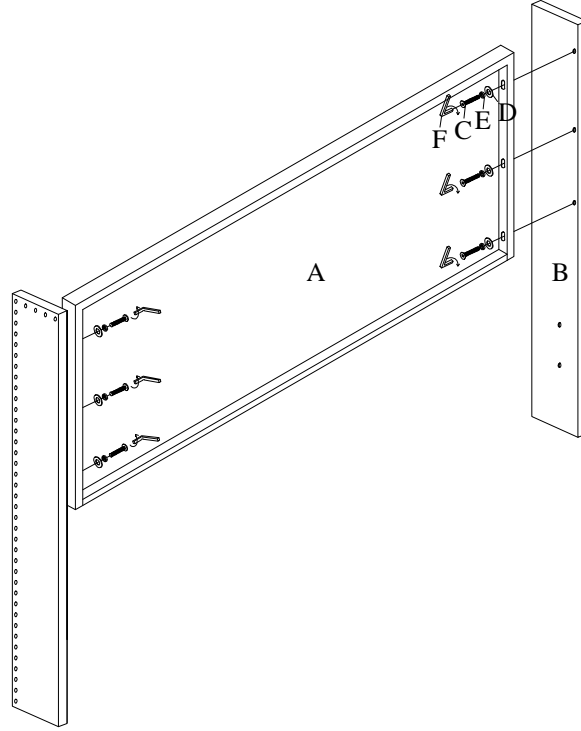

2

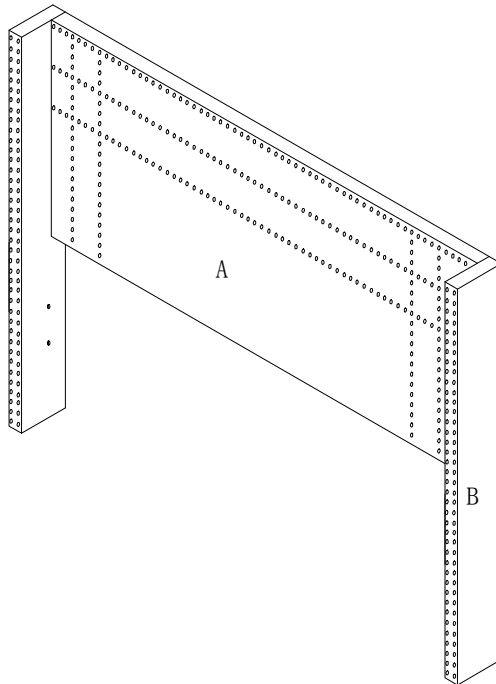

Thank you for your purchase.