

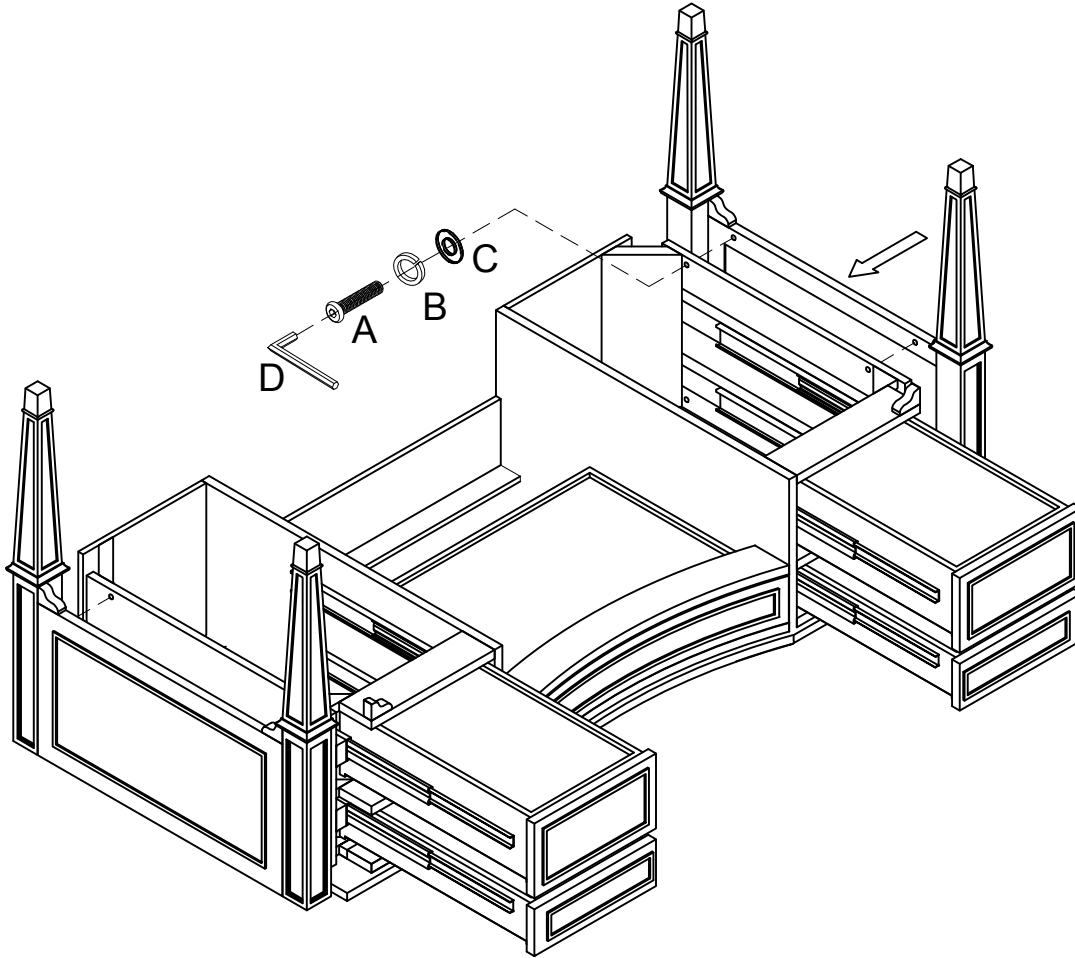







ASSEMBLY INSTRUCTIONS

SKU#87090

Step 1



Hardware fittings list

No.	Hardware	Sketch	Q'ty
A	Bolt		8PCS
B	Lock Washer		8PCS
C	Washer		8PCS
D	Wrench		1PCS
E	Handle (Ø27*25)		2PCS
F	Short Bolt (M4*35)		4PC
G	Handle(Ø21*20)		3PC
H	Short Bolt (M4*25)		1PC



AJ08-U1 Desk







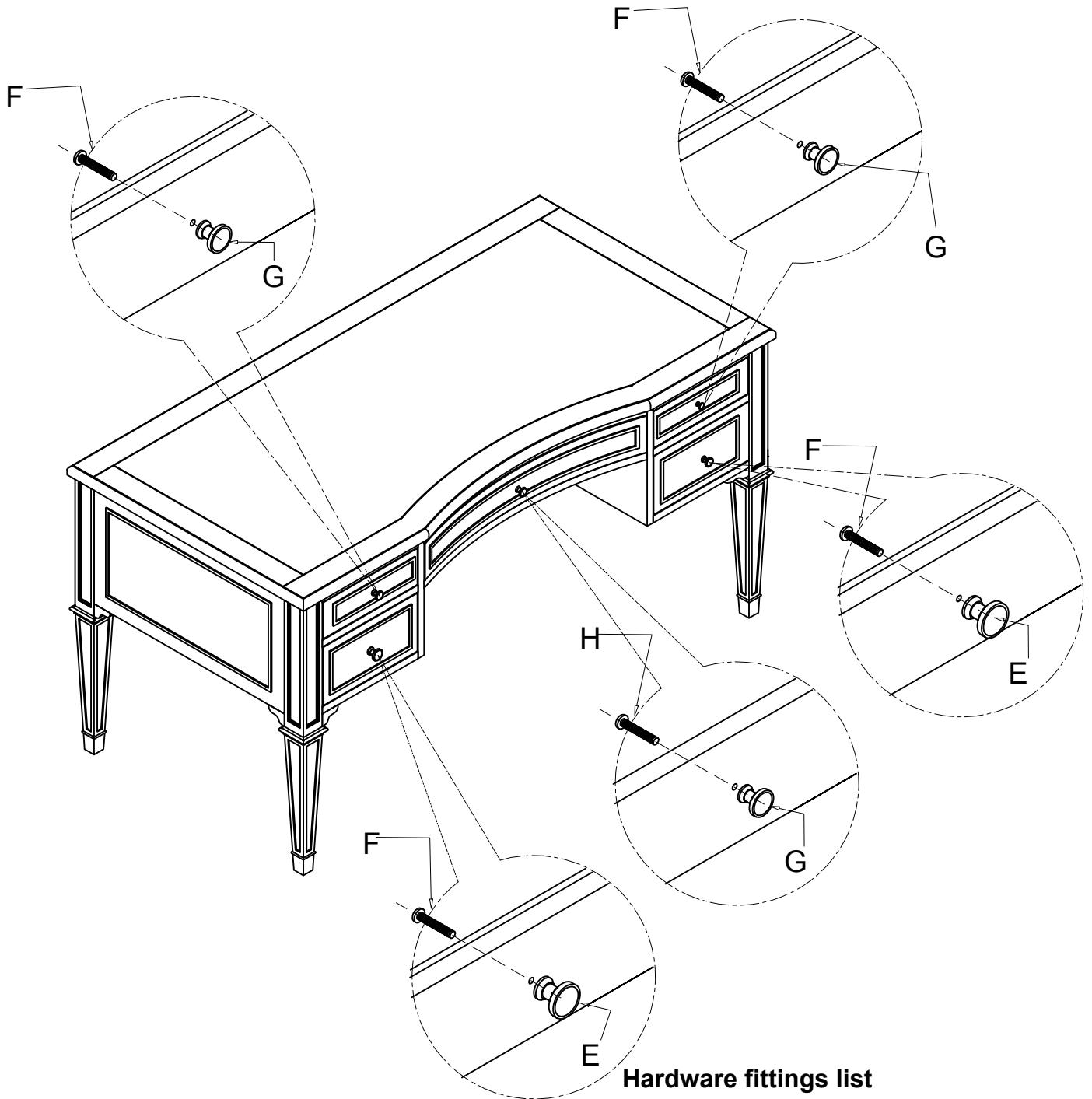

ASSEMBLY INSTRUCTIONS

SKU#87090

Step 2



Hardware fittings list

No.	Hardware	Sketch	Q'ty
A	Bolt		8PCS
B	Lock Washer		8PCS
C	Washer		8PCS
D	Wrench		1PCS
E	Handle (Ø27*25)		2PCS
F	Short Bolt (M4*35)		4PC
G	Handle(Ø21*20)		3PC
H	Short Bolt (M4*25)		1PC



AJ08-U1 Desk